

# SWEDX

Your Digital Signage Partner

## User's Guide

SDS28K8-01  
SDS32K8-01  
SDS40K8-01  
SDS43K8-01  
SDS50K8-01  
SDS58K8-01  
SDS65K8-01  
SDS75K8-01

MX-40K8-01  
MX-50K8-01  
MX-58K8-01  
MX-65K8-01  
MX-75K8-01

UMX-49K8-01  
UMX-55K8-01  
SUMX-55K8-01

SWL-28K8  
SWL-32K8  
SWL-40K8  
SWL-50K8  
SWL-58K8  
SWL-65K8  
SWL-75K8

SWLT-28K8  
SWLT-32K8  
SWLT-40K8  
SWLT-50K8  
SWLT-58K8

SWSB32K8

40"

Digital Signage Screen

50"

Digital Signage Screen

58"

Digital Signage Screen

65"

Digital Signage Screen

75"

Digital Signage Screen



SWEDX Matrix Video Walls



SWEDX Sandwich Board



SWEDX Lamina



Digital Signage Screens

SWEDX offers a wide range of LED-TVs and digital signage products and its accessories. For more information please visit [www.swedx.com](http://www.swedx.com)



SWEDX Signo

### Lamina Accessories



Digital Signage Player (Windows/Android)

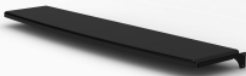

Front/Back Shelf



Flightcase



Top Banner



Side Shelf



Protection Ring

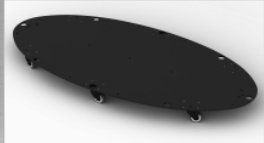

Mobile base with lockable wheels

INDEX	Page
Introduction	4
Safety precaution	4
Basic operation	5
Contents	6
Inputs	6
SWL/SWLT specific information	7
Remote Control For SDS/SWL/SWLT	8
Remote control buttons (FR5)	9
Remote control buttons (FR-IR)	10
Main Operations	11
Volume Control	11
OSD Menu Operations	11
OSD Menu Structure	11
Picture Menu	12
Sound Menu	13
Time Menu	14
Settings Menu	15
Media Player 1/2	17
Supported Formats and Codes	18
Matrix Video Wall Information	19
Troubleshooting	21
Warranty and Service	22
How to get service	23
Limitation of liability	23

## **Introduction**

Thank you for choosing SWEDX Digital Signage products. Please read this manual thoroughly before operating the product. Make sure the display was not damaged in transit. Should the product be damaged, please contact your dealer and do not install it. Check that you have all the accessories according to the model.

## **Safety precaution**

- Do not place the product on unstable places, from which it may fall off
- Do not expose the product to extreme temperature and humid environment
- Avoid subjecting the product to direct sunlight or other heat sources
- Do not put the product into any liquid
- Do not put anything inside the product, or place water container on top of the it
- In thunder rainy days (especially with lightning), please unplug the power and antenna cables
- Do not step on the power cable, or tangle them together
- Avoid overload of the exterior electric outlet to prevent fire hazard of electric shock
- Clean the product with dry and soft fabric
- If your product is broken, do not repair it by yourself, but contact the maintenance personnel
- If the remote control is left unused for a longtime, please take the batteries out and store them in dry places
- Avoid dropping the remote control
- If the product is installed for exhibition purpose, please do not place the overheated part on the ground or carpet to prevent accident
- The apparatus shall not be exposed to dripping or splashing and that no object filled with liquids, such as vases, shall be placed on the apparatus
- Where the MAINS plug or an appliance coupler is used as a disconnect device, the disconnect device shall remain readily operable
- Battery shall not be exposed to excessive heat such as sunshine, fire or the like
- Excessive sound pressure from earphones and headphone can cause hearing loss

Please install the product at proper position, such as wall or ceiling. Please install it under the guidance of professional staff.

This device complies with Part 15 of the FCC Rules. Operation is subject to the following two conditions:

1. This device may not cause harmful interference

2. This device must accept any interference received, including interference that may cause undesired operation

Please disconnect the power cord if this equipment will not be used for a long time.

## **Precautions When Displaying a Still Image**

A still image may cause permanent damage to the screen

- Do not display a still image on the screen for more than 2 hours as it can cause screen image retention. This image retention is also known as "screen burn". To avoid such image retention, reduce the degree of brightness and contrast of the screen when displaying a still image
- Watching the screen in 4:3 format for a long period of time may leave traces of borders displayed on the left, right and center of the screen caused by the difference of light emission on the screen. Playing a DVD or a game console may cause a similar effect to the screen. Damages caused by the above effect are not covered by the Warranty.
- Displaying still images from Video games and PC for longer than a certain period of time may produce partial after-images. To prevent this effect, reduce the 'brightness' and 'contrast' when displaying still images



### **WARNING**

**To prevent the spread of fire, keep candles or other open flames away from this product at all times**

### Basic operation

- Use AC 100-240V 50~60 Hz power outlet for the product power supply
- If the screen of the product is not on, please press the power button on the remote control or on the product
- If you want to shut off the product temporary, please press the power button on the remote control or on the product
- If you want to shut off the product completely, please disconnect the power cable
- In **Component** and **AV** modes the product will **shut off** if there is no signal input for **30 minutes**
- In **PC-RGB** and **HDMI** modes the product will enter **idle** state if there is no signal input after **30 seconds**
- In **Media Player 1/2** modes the product will remain **On** if there is no signal input
- The setting and tuning of picture and sound will be saved when the product is shut off, which will be working in the pre-shut off state when the product is turned on again
- If PC signal source is used, please first set the resolution of the PC display card as the following modes:  
For HDMI 1/2/3 (3840x2160 @ 60Hz)  
For PC (1920 x 1080 @ 60Hz)
- If there is progressive output of the signal used by the user, signal source with progressive output is recommended

### Preparation

- Put the product on a stable surface
- Do not fix the product with others fixations than those provided or suggested by the manufacturer
- If you have a wall mount, check that it is steady.
- Do not place any material on the product.
- Do not block or cover the ventilation openings on the product
- The product must be plugged with a tension source of 110-240 volts and 50~60 Hz
- Power cord and cables must be properly routed and protected to prevent from stepping on them
- Keep the power cord away from any heat source. Possible fire hazard

### Heating sources and humidity

- Keep the product dry and away from humidity
- Keep the product away from heat sources  
Cleaning and maintenance
- Unplug the product before cleaning it. Do not use solvents or liquids to clean the product
- Only clean the product with a soft and dry fabric
- In case of troubleshooting, do not use spare parts other than those suggested by the manufacturer. Using inadequate spare parts can lead to electric shocks, short-circuits fire

or others incidents. Please contact a technical authorized by SWEDX

### Departure in holidays

- Unplug the product during lightning storms or when unused for long periods of time

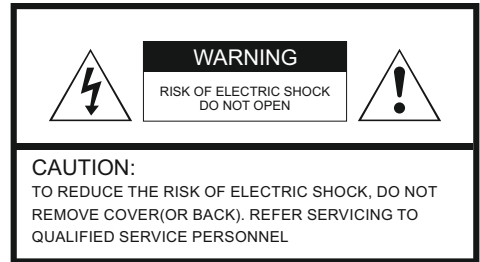

### WARNING:

TO REDUCE THE RISK OF FIRE OR ELECTRIC SHOCK, DO NOT EXPOSE THIS APPARATUS TO RAIN OR MOISTURE

## Contents

Included items:



2 x AAA Battery



Notice



AC Cable



Remote Control



LED Screen



IR Cable\*

\*MX/UMX only

### CAUTION

Danger of explosion if battery is incorrectly replaced. Replace only with the same or equivalent type



AAA Battery

### CAUTION

The batteries shall not be exposed to excessive heat such as sunshine, fire or the like



AAA Battery

## Inputs

### 1. PC

Input for PC (VGA) sources

### 2. PC AUDIO

Input for PC audio when PC (Personal Computer) is connected

### 3. COMPONENT

Input for Component (YPBPR) sources.  
Supports maximum resolution 1080p @ 60 Hz  
\*Component/YPBPR and AV shares the same audio input

### 4. AV

Input for AV (Audio/Video) sources

### 5. IR\*

Input for external infrared receiver. See Matrix function

### 6. RS232 OUT\*

Output for RS232 signal. See Matrix function

### 6. RS232 IN\*

Input for RS232 signal. See Matrix function

### 8. LED

LED indicator for power status

### 9. On/OFF

Key to power the product On/Off

### 10. Remote Pairing

Key to pair the remote control with the product

### 11. POWER INPUT

Input for 100-240 V power 50~60Hz

### 12. MEDIA PLAYER 1

Input for USB Media Player 1/Firmware upgrade

### 13. MEDIA PLAYER 2

Input for USB Media Player 2

### 14. HDMI1

Input for HDMI1 (Ver. 2.0). Supports maximum resolution 3840x2160 @ 60 Hz

### 15. HDMI2 (ARC)

Input for HDMI2 (Ver. 2.0). Supports maximum resolution 3840x2160 @ 60 Hz  
HDMI2 supports ARC (Audio Return Channel)

### 16. HDMI3

Input for HDMI3 (Ver. 2.0). Supports maximum resolution 3840x2160 @ 60 Hz.

### 17. COAXIAL

Output for digital audio signal (Coaxial)

\* Inputs 5, 6 and 7 are available only in MX/UMX series

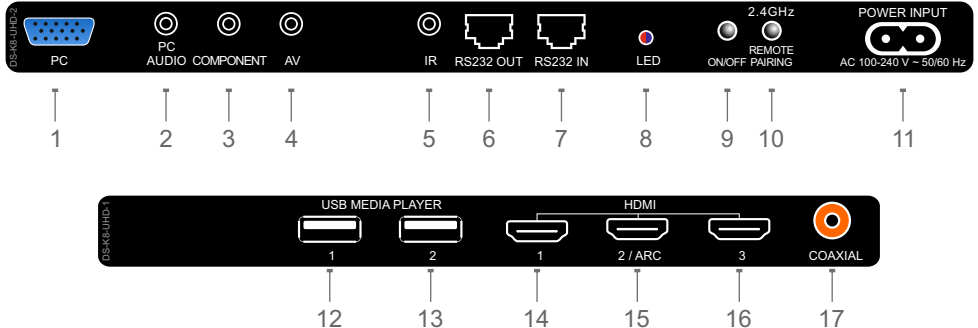

## SWL/SWLT specific information

The **SWL/SWLT** series are equipped with external inputs to provide easy access.

The external inputs are



USB external input. It can be connected to Media Player 1 or 2. It can also be connected to a media player such as Mini PC or Android box



Rj45 input. It could be connected to a Mini PC or Android box to access the network in case WiFi is not available or LAN connection is preferred.



The **SWL/SWLT** series are also equipped with cooling fans. The fans can be controller in the OSD menu.



The **SWLT** (Touch) series are equipped with a Touch overlay. The connection interface is USB 2.0. The Touch USB cable must be connected to a media player such as Mini PC or Android box etc which supports touch function.

## SWL/SWLT Contents

Included items for SWL/SWLT series:

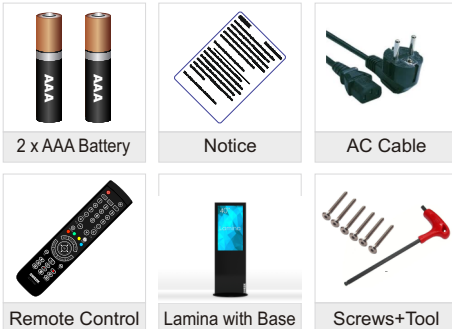

## Lamina base assembly instructions

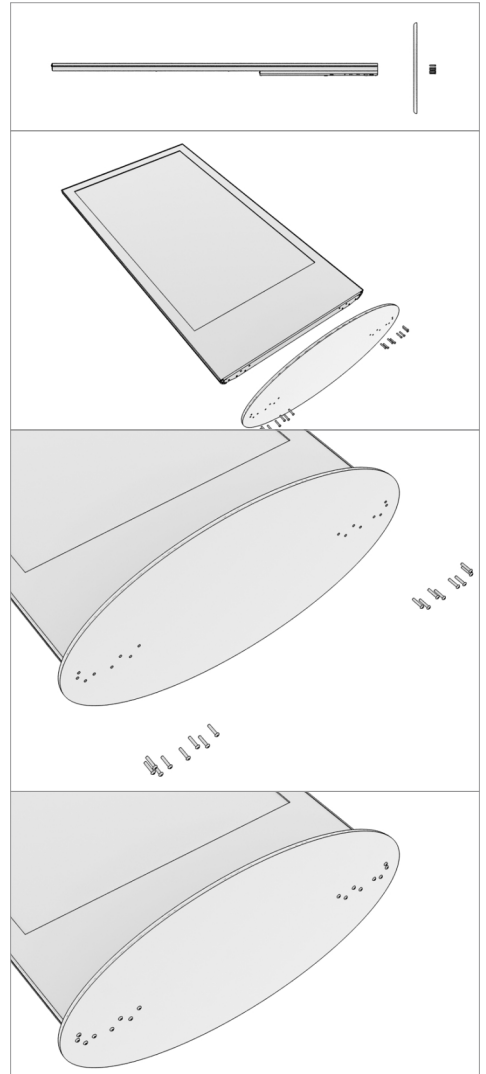

## Remote Control for SDS/SWL/SWLT-series (FR5)

The remote control is based on both 2.4 GHz and Infrared.

The remote control is equipped with LED indicators. The **RED** indicator states that the remote is in **Infrared** mode and the **BLUE** indicator is for **2.4 GHz** mode. Recent products from SWEDX uses 2.4 GHz receivers.

The 2.4 GHz technology allows the remote to control the TV without targeting it because the receiver is built inside the product. Each SWEDX product has a pre-configured remote control meaning that if you have several SWEDX products then the remote control for one of the products will function only with that particular product and not with the other products.

To switch between Infrared and 2.4 GHz mode press and hold the buttons for 5 seconds. The Red LED will flash 3 times and switch from the current mode to the other one.



To pair the remote with the product follow the steps below

1. Disconnect the product from power outlet
2. Make sure that the remote is in 2.4 GHz mode
3. Make sure that the USB Remote



4. Receiver is inserted in the screen  
Press and hold the buttons 0 and OK on the remote control simultaneously for about 5 seconds. The BLUE LED will flash 5 times indicating that the remote is now in pairing mode with the product



5. Connect the product to power. The remote will pair automatically and the BLUE LED light will stop flashing

A On/Off key is also available in recent SWEDX products.



The remote control "FR5" is included in the **SDS-series** (digital signage screens). For the **MX/UMX-series** the included remote control is model "FR" (see page 9)





## Remote control buttons (FR5)

1. On/Off button
2. Shortcut to HDMI1,2,3
3. Number buttons for direct channel access
4. Display additional information
5. Volume increase
6. Volume decrease
7. Picture freeze
8. RED
9. GREEN
10. *Not applicable for this product*
11. Navigation button UP
12. Navigation/adjust button LEFT
13. Navigation button DOWN
14. Menu display. In OSD sub-menu press to access previous menu
15. *Not applicable for this product*
16. Shortcut to Media Player 1,2
17. Aspect Ratio toggling
18. Start/Pause play
19. Stop play
20. Fast backward
21. Previous Title
22. *Not applicable for this product*
23. Mute the built-in speakers
24. Available sources selection
25. *Not applicable for this product*
26. *Not applicable for this product*
27. *Not applicable for this product*
28. *Not applicable for this product*
29. Enter sleep mode in certain chosen time
30. Blue
31. Yellow
32. *Not applicable for this product*
33. *Not applicable for this product*
34. Confirm/activate button
35. Navigation/adjust button RIGHT
36. Exit the OSD
37. *Not applicable for this product*
38. Shortcut to AV
39. *Not applicable for this product*
40. Fast forward
41. Next Title
42. *Not applicable for this product*

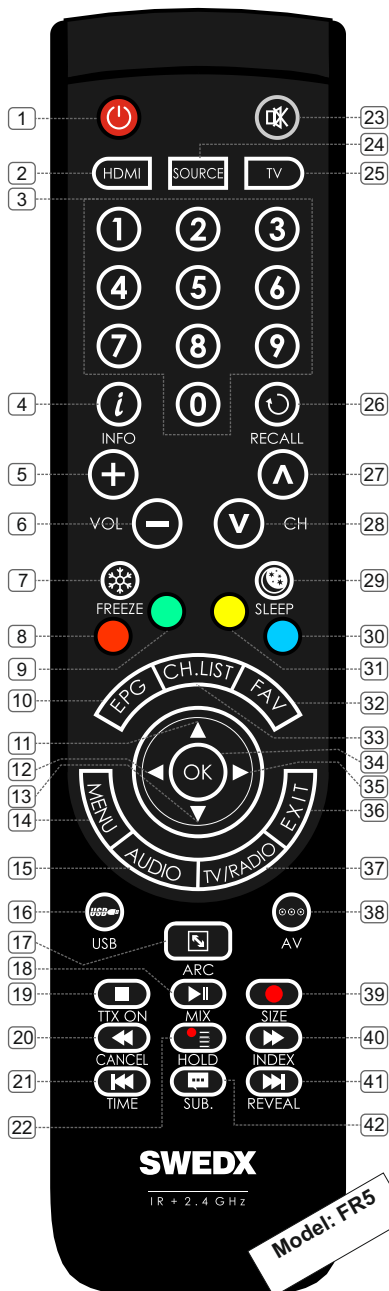

## Remote control buttons (FR-IR)

1. On/Off button
2. Shortcut to HDMI1,2,3
3. Number buttons for direct channel access
4. Display additional information
5. Volume increase
6. Volume decrease
7. Picture freeze
8. RED
9. GREEN
10. *Not applicable for this product*
11. Navigation button UP
12. Navigation/adjust button LEFT
13. Navigation button DOWN
14. Menu display. In OSD sub-menu press to access previous menu
15. *Not applicable for this product*
16. Shortcut to Media Player 1,2
17. Aspect Ratio toggling
18. Start/Pause play
19. Stop play
20. Fast backward
21. Previous Title
22. *Not applicable for this product*
23. Mute the built-in speakers
24. Available sources selection
25. *Not applicable for this product*
26. *Not applicable for this product*
27. *Not applicable for this product*
28. *Not applicable for this product*
29. Enter sleep mode in certain chosen time
30. Blue
31. Yellow
32. *Not applicable for this product*
33. *Not applicable for this product*
34. Confirm/activate button
35. Navigation/adjust button RIGHT
36. Exit the OSD

37. *Not applicable for this product*
38. Shortcut to AV
39. *Not applicable for this product*
40. Fast forward
41. Next Title
42. *Not applicable for this product*

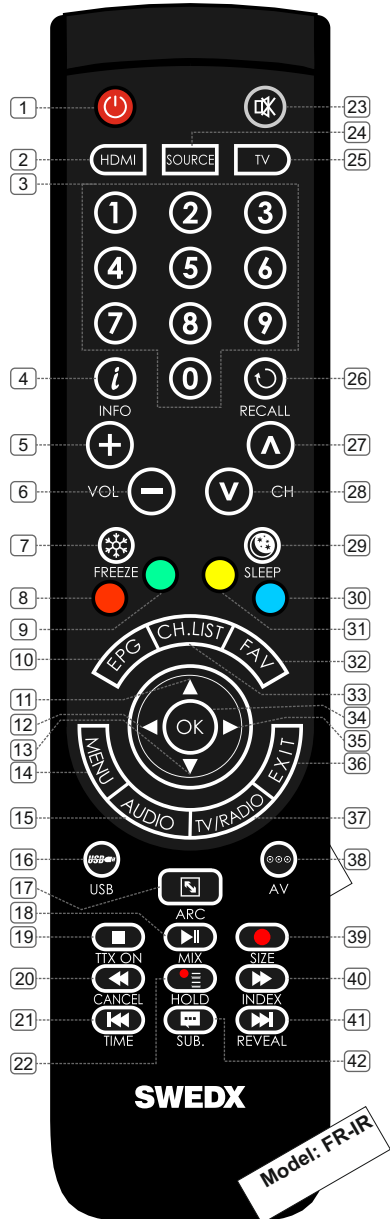

The remote control "FR-IR" is included in the **UMX/MX-series** (Matrix video wall screens). For the **SDS-series** the included remote control is model "FR5" (see page 7)

In order to control the UMX/MX screens with the "FR" remote control an external Infrared receiver must be connected to the screens IR input (see page 6 input No. 5)



## Main Operations

### Turning On And Off



The product turns on automatically when it is connected to power. When the product is in Stand-by mode press **POWER** on the remote control or the On/Off button on the control buttons. The product will turn on and will be ready to be used.

### Select Source

**SOURCE**

Press **SOURCE** on the remote control. The source list menu will appear. Navigate the list with



**Up/Down** on the remote control to select the source and confirm by pressing **OK**.



## Volume Control



Press **VOL+ / VOL-** on the remote control to adjust the volume level.



Press the **MUTE** on the remote control to mute the sound.



## OSD Menu Operation



- Press **MENU** on the remote control to access the OSD Menu. Pressing the same button again will move you backward in the OSD structure.
- Press **OK** button to confirm/select.
- Use **LEFT & RIGHT** buttons to navigate or change the parameters of the current

sub-menu.

- Use **UP & DOWN** buttons to navigate in the OSD Menu.
- Press **EXIT** button to exit the OSD Menu.

## OSD Menu Structure

- OSD (On Screen Display) allows users to control or adjust various features and settings in accordance with desired preferences.
- Press the **MENU** button on the remote control to see the main OSD menu.



## OSD Menu Operation:

- Main Menu:** Press **MENU** on the remote control to enter the main OSD menu. First, choose Main menu item you need with the buttons **◀ & ▶**. To select a Main menu items, just press **OK**.
- Sub Menu:** Each menu item has its own sub menu items to set.
- Sub Menu items:**
  - A: If there is no value to adjust it means there is a sub menu which you can access by pressing **OK** and modify the menu values.
  - B: If there is no **▶** part, the item has adjustable values. Use **◀ & ▶** to adjust the values.
  - C: If the sub-menu item is grey colored, it means this item is not available in the particular mode.

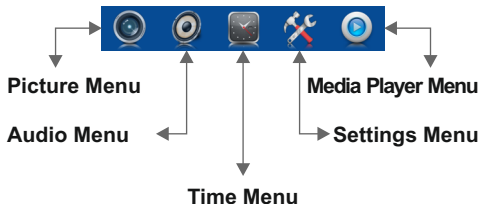

## Picture



Use the Picture menu to adjust the picture settings to meet your requirements:

### Picture mode

**Standard:** Suitable for a normal room

**Mild:** Suitable for a dark room

**User:** In User mode you can adjust the Contrast, Brightness, Color, Sharpness to meet your requirements

**Dynamic:** Suitable for a bright room

### Aspect Ratio

Set the various picture options such as picture size and aspect ratio.

*Depending on the input source, the picture size options may vary.*

*The connected device to the controller may have its own set of screen sizes as well. However, it is highly recommended to use PointToPoint / Just Scan mode.*

### Auto

Automatically adjusts the picture size to the signal

### Zoom1&2

Magnifies the picture size.

### 4:3

Sets the picture to basic (4:3) mode.

*Do not watch in 4:3 format for a long time. Traces of borders displayed on the left, right and center of the screen may cause image retention (screen burn) which are not covered by the warranty.*

### PointToPoint

Displays the signal without any cut-off when HDMI (720p / 1080i / 1080p / 2160p) signals. The PointToPoint mode will display without scaling

which means if the signal resolution is lower than 3840x2160 then the picture will be shown according to its original size.

### Just Scan

Just Scan mode will display crispier picture with scaling to fill the entire screen.

### Noise Reduction

Choose to activate noise reduction. Available options are Off, Low, Middle and High.

*If the signal received by the input controller is weak, you can activate the Noise Reduction feature to help reduce any static and ghosting that may appear on the screen.*

### Color Temperature

Choose between predefined settings (User, Warm, Medium and Cold). In User mode you can adjust the Red, Green and Blue color temperature.

### Screen (only in PC mode)

When the TV is in PC-Mode additional settings are available for PC-Setup.

**H-Offset:** Adjust the PC's screen positioning horizontally

**V-Offset:** Adjust the PC's screen positioning vertically

**Size:** Adjust the screen size

**Phase:** Adjust the signal phase

### Local Dimming

Local dimming is a feature that dims the backlight behind parts of the screen that are displaying black. This makes blacks appear deeper and darker on those parts of the screen, which can be a big bonus when watching video with darker scenes.

### Backlight

Adjust the backlight intensity.

## Sound



Use the Sound menu to adjust the sound settings to meet desired requirements:

### **Sound Mode**

Choose between predefined settings:

**Standard:** Suitable for normal programs

**Music:** Suitable for music program

**Movie:** Suitable for movies

**Sports:** Suitable for sport programs

**User:** In User mode you can adjust the Treble and Bass to meet desired requirements.

### **Balance**

Adjust the sound output balance between left and right speaker.

### **Surround Sound**

In TrueSurround or SRS TrueSurround mode the screen delivers a compelling, virtual surround sound experience through the internal television speakers. It is fully compatible with all multichannel formats.

### **SPDIF Mode**

Choose the output mode for the SPDIF signal. Choose between Auto or PCM.

## Time

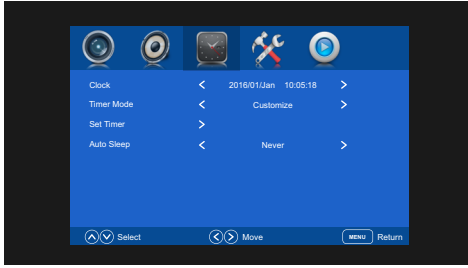

## Clock

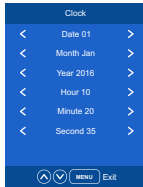

Use the Time menu to set the date and time for the product. The date and time are important for usage of the timer function.

Set the date and time under the Clock option by choosing the clock option and pressing the ► button. Change the values to the correct time by pressing the ◀ & ▶ buttons. Press Menu to exit and save the new date and time settings.

## Timer Mode

The product is equipped with advanced timer settings. When activated, the timer settings provide 3 modes for the timer function. Only one mode can be activated at time. Each mode has 5 timer sets (Time 1, 2, 3, 4 and 5). It is possible to activate one or more time sets

**Once:** The product will turn on/off once according to the defined On Time and Off Time.

**Everyday:** The product will turn on/off everyday according to the On Time and Off Time. This function is suitable of the product is used everyday.

**Customize:** In customize mode you can define the on/off time for Monday~Friday and/or Saturday and/or Sunday.

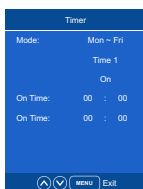

## Timer example:

Timer Mode: Customize

Mode: Mon~Fri

Time 1: ON

On Time: 08:00

Off Time: 13:00

Mode: Saturday

Time 1: ON

On Time: 10:00

Off Time: 13:00

Mode: Sunday

Time 1: ON

On Time: 11:00

Off Time: 13:00

Mode: Mon~Fri

Time 2: ON

On Time: 14:00

Off Time: 21:00

Mode: Saturday

Time 2: ON

On Time: 14:00

Off Time: 20:00

Mode: Sunday

Time 2: ON

On Time: 14:00

Off Time: 19:00

Monday	Tuesday	Wednesday	Thursday	Friday	Saturday	Sunday
00	00	00	00	00	00	00
01	01	01	01	01	01	01
02	02	02	02	02	02	02
03	03	03	03	03	03	03
04	04	04	04	04	04	04
05	05	05	05	05	05	05
06	06	06	06	06	06	06
07	07	07	07	07	07	07
08	08	08	08	08	08	08
09	09	09	09	09	09	09
10	10	10	10	10	10	10
11	11	11	11	11	11	11
12	12	12	12	12	12	12
13	13	13	13	13	13	13
14	14	14	14	14	14	14
15	15	15	15	15	15	15
16	16	16	16	16	16	16
17	17	17	17	17	17	17
18	18	18	18	18	18	18
19	19	19	19	19	19	19
20	20	20	20	20	20	20
21	21	21	21	21	21	21
22	22	22	22	22	22	22
23	23	23	23	23	23	23

On Time     On Time     Off Time

## Auto sleep

This function will put the product into Off mode in given time. Choose between Never, 4, 6 or 8 hours.

## Settings

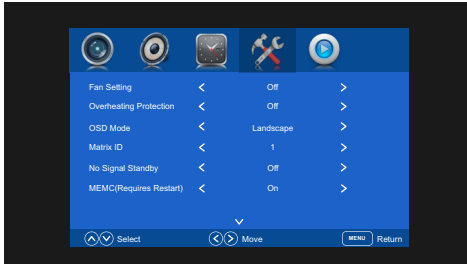

### **OSD Language:**

Choose the OSD language. Available languages are English, Deutsch, Spanish, French, Italian, German, Japanese, Swedish, Arabic, Simplified Chinese.

### **Restore Factory Default**

This function will restore the product to the factory defaults and will erase any customized settings.

### **HDMI CEC**

Activate the HDMI CEC function.

### **HDMI ARC**

Activate HDMI ARC (Audio Return Channel) function.

### **Auto Standby**

When activated the product will be put into standby mode when a HDMI CEC compatible device is connected and turned off.

### **Auto On**

When activated the product will be put into On mode when a HDMI CEC compatible device is connected and turned on.

### **Device Control**

When activated the HDMI CEC compatible device can be controlled using the product's remote control.

### **Device List**

Displays connected HDMI CEC compatible devices.

### **Color Range**

Choose the scope of the color range. Available options

### **EDID Mode**

This is an informative feature to display the HDMI mode of the connected product to the HDMI input. Available options are HDMI 1.4 or HDMI 2.0. Products with support for HDMI 2.0 are recommended to take full advantage of the 4K feature in Swedx product.

### **No Signal Screen**

Change the background color of the display when no signal is detected. Available options are black or blue.

### **Activate Fans at °C**

Activate the product's ventilation/cooling fans (if available) at the defined degree.

### **Fan Setting**

Choose the setting for the product's ventilation/cooling fans (if available). Available options are Off, low, medium, high. Choose low or medium when the product is used in quite environment and choose high when the maximum cooling is desired due to the environment.

### **Overheating Protection**

When activated this function will turn off the product in order to protect it from damages if it reaches too high temperature. Available options are Off, 80 or 85°C.

### **OSD Mode**

Choose the orientation for the OSD menu. Choose landscape for horizontal mode and portrait for vertical mode.

### **Matrix ID**

Set the screen's ID when the product is used in Matrix video wall configuration. See page19 for details.

### **No Signal Standby**

The product is equipped with Smart HDMI function. When the product is in HDMI mode you can activate the Smart HDMI function by setting the No Signal Standby to On mode and the product will go into sleep mode in 30 seconds if no HDMI signal is detected. The product will automatically wake up when the HDMI signal is detected. This function is useful if you want to control the product's sleep/wake up mode by the source connected to the HDMI inputs.

To deactivate the function set the No Signal Standby to Off mode.

## **MEMC (Motion Estimation/Motion Compensation)**



Enhancement to compensate the difference between the screens refresh rate and signal frame rate. Active for smoother motion and deactivate for shorter input lag.



## Media Player 1/2

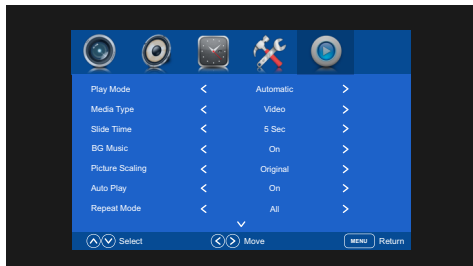

This product is equipped with an advanced and user friendly media player. The Media player can display videos and images stored in a USB flash drive connected to the Media Player 1 or 2 inputs. See next page for which formats and codecs are supported.

### Play Mode

In Play Mode you can choose between Automatic or Program.

**Automatic** will display all files stored in the USB flash drive connected automatically.

**Program** will allow to create a play list of selected files stored in the USB flash drive.

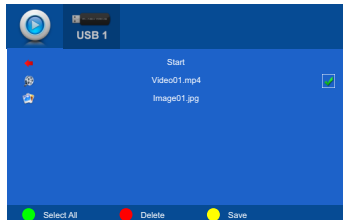

To create a play list select all files by pressing **GREEN** button on the remote or select the files to be displayed by highlighting the file and pressing **OK** button on the remote. When the file/files is/are selected a check mark will appear beside the file name. To save the play list press the **YELLOW** button on the remote control.

To run the play list press the play button on the remote or highlight the Start and press **OK**. To stop running the play list press the STOP or EXIT button on the remote.

To delete a file from the USB flash drive highlight it and press the **RED** button on the remote.

### Media Type

Available options are All, Video and Picture. When the Play Mode is **Automatic** it allows to choose between **All**, **Video** or **Picture**. When All

is chosen the product will display automatically all video and picture files stored in the USB flash drive.

When Video is chosen the product will display automatically only all video files stored in the USB flash memory.

When Picture is chosen the product will display automatically only all picture files stored in the USB flash memory.

When the Play Mode is Program you can choose to display in the play list either videos or pictures that are stored in the USB flash drive.

### Slide Time

Select the time duration for the picture to be displayed before next picture is displayed. The options are:

**Seconds:** 5, 10, 15, 20, 25, 30, 45

**Minutes:** 1, 5, 10, 30

**Hours:** 1, 3, 12, 24

### BG Music

Allows to play background music while displaying pictures. See next page for supported audio files.

### Picture Scaling

For picture where the **aspect ratio is not 16:9** you can choose how the product will display the picture. In **Original** mode the picture will be displayed in full screen while keeping the picture's proportion. In **Full Screen** mode the picture will be displayed to cover the whole screen ignoring the picture's proportion. See the illustration below

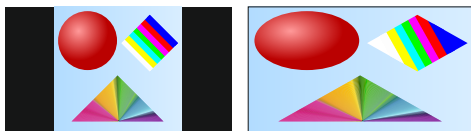

Original

Full Screen

### Auto Play

Available options are On and Off. When the Auto Play mode is **On** the product will start to display the files automatically when the product is turned on. When the Auto Play mode is **Off** the product will show the content of the connect USB flash drive when the product is turned on.

### Repeat Mode

Allows to choose the repeat mode of the files. Available options All, Once, Cancel.

**All** will repeat displaying the files continuously

**Once** will repeat displaying the files once

**Cancel** will not repeat displaying the files

## Supported Formats and Codecs

	Format	Video Codec	Audio Codec	Resolution	Frame Rate	Mbit/s	
Video	AVI	MJPEG	MP3, WMA, AAC, MP2, PCM	640x480	23,976~30≤ 16Mbps	≤ 10Mbps	
		DIVX.311/DIVX4/DIVX5		720x576		≤ 10Mbps	
		XVID/MPEG-2/MPEG4/H.264		1920x1080		≤ 20Mbps	
	MP4	MPEG-2/MPEG-4/H.264				≤ 40Mbps	
	TS	MPEG-2					
	TRP						
	MPG	MPEG-1/MPEG-2					≤ 20Mbps
	NOV	MPEG-4/H.264					
	MKV						
	DAT	MPEG1				MP2	352X288
	VOB	MPEG2		720x576			
Format	Max resolution	Colors					
Picture	BMP	1000 x 1000 pixels	16, 256, 16 bit, 24 bit och 32 bit.				
	JPEG	3840x2160 / <b>Recommended resolution is 3840x2160 pixels</b>					
	PNG	1000x1000 pixels					
Audio	MP3	8K-48K. 32K+320K					
	WAV	32K-48KHz 32K-320Kbps					
	M4A, AAC	16K-48K. 32K+192K					

### Information:

The Media Player inputs supports:

USB Flash Drive and Hard disks are supported. Supported formatting formats are, NTFS, FAT32, FAT16. NTFS Compressed is not supported.

**The files must be saved in the root folder. Folder structure is not supported.**

Max 5000 files.

### Matrix Video Wall Information

In matrix video wall screens the following items are included (SMC = Swedx Matrix Kit)  
 HDMI splitter  
 HDMI cables  
 Network cables  
 Infrared remote receiver  
 RJ45 to RS232 adapter  
 RS232 to USB adapter

### Matrix Video Wall Software Information

To configure the video wall screens to show 1:1 image/video on the entire video wall follow the steps below

Download the LCDWall software from the link below

[https://www.swedx.se/download/lcdwall/lcd\\_w\\_all\\_k9\\_v5.00.rar](https://www.swedx.se/download/lcdwall/lcd_w_all_k9_v5.00.rar)

Extract the file and install it on Windows PC

*If you face problem when you run the software then run it in compatibility mode XP Sp2*

Security	Details	Previous Versions
General	Shortcut	Compatibility

If this program isn't working correctly on this version of Windows, try running the compatibility troubleshooter.

Run compatibility troubleshooter

[How do I choose compatibility settings manually?](#)

Compatibility mode

Run this program in compatibility mode for:

Windows XP (Service Pack 2)

Settings

Reduced color mode

8-bit (256) color

Run in 640 x 480 screen resolution

Disable fullscreen optimizations

Run this program as an administrator

Change high DPI settings

Change settings for all users

Connect the RS232 to USB adapter to the PC's USB port



Check the Com port number assigned by Windows to the RS232 to USB adapter

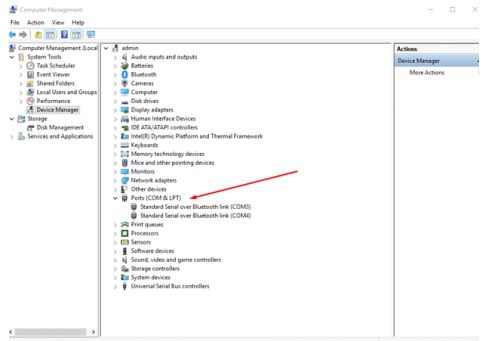

Connect the RJ45 to RS232 adapter to the RS232 to USB adapter



Connect the RJ45 cable to the RS232 to RJ45 adapter



Connect the RJ45 cable other end to the first screen's RS232 IN

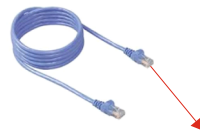

Assign the Matrix ID to each screen in the setting menu (see page 15) using the remote control and the infrared cable. The figure below illustrates 3x3 setup viewed from the front side

ID 1	ID 2	ID 3
ID 4	ID 5	ID 6
ID 7	ID 8	ID 9

Connect the RS232 OUT from the first screen to the RS232 IN in the second screen and so on according to the figure below



The figure above illustrate 3x3 setup but the principal is the same for other setups

Distribute the HDMI signal to the screens using the included HDMI splitters and cables according to the figure below

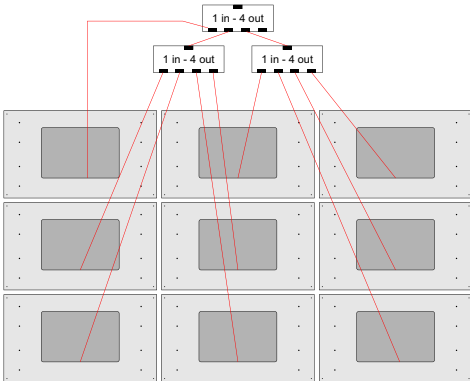

Start the LCD Wall Software (the password is 1)

Choose Set screen in the System Menu

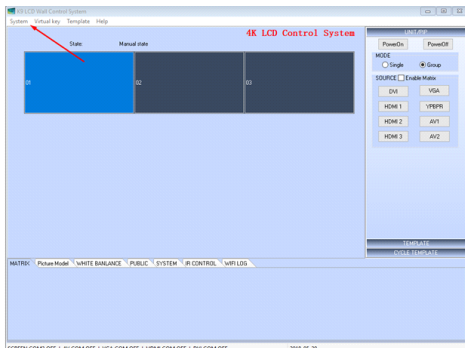

In the Set screen options set the following:  
 Serial: Set the COM-port number assigned in the device manager  
 Row: Set the desired rows quantity  
 Col: Set the desired columns quantity  
 Unit Width: Input the screen's width  
 Unit Height: Input the screen's height  
 Vertical Split/Horizontal split: Adjust these values to achieve desired GAP/BEZEL to be removed or offset of the picture sent to the screens (or to compensate the BEZEL)

**NOTE:** The screens indicate accepting the set configuration by FLASHING (after you click on the OK button). If the screens did not flash, please use the Set Screen Menu to set the configuration again.

Press OK to save the settings. The software will ask for restart

After the software restarts select all screens,

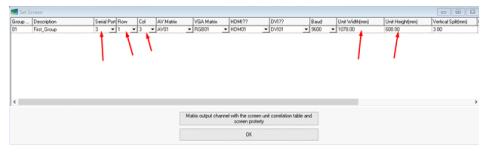

choose Group and click on the HDMI input that the screens are connected with

After pressing the HDMI input the screens will

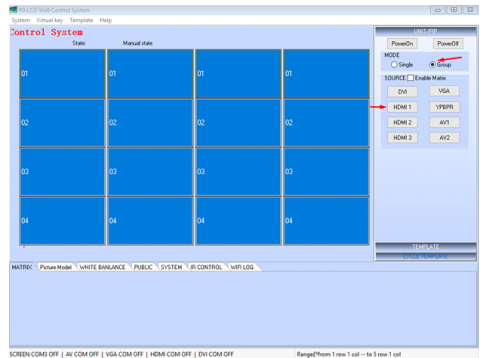

show full picture on all screens together. If you want to show single picture on each screen choose Single and click the HDMI input

## **Troubleshooting**

Before contacting SWEDX service or your dealer, perform the following simple checks. If you cannot solve the problem using the instructions below, note the model and serial number of your product and contact your local dealer

### **No sound or picture**

- Check that the mains lead has been connected to a wall socket
- Check the picture contrast and brightness settings
- Check the volume

### **Normal picture but no sound**

- Check the volume
- Check whether the MUTE button has been pressed on the remote control

### **No picture or black and white picture**

- Adjust the color settings
- Check that the broadcast system selected is correct

### **Sound and picture interference**

- Try to identify the electrical appliance that is affecting the set and move it further away.
- Plug your set into a different mains socket

### **Blurred or snowy picture, distorted sound**

- Check the direction, location and connections of your aerial
- This interference is often due to the use of an indoor aerial

### **Remote control malfunctions**

- Ensure that the remote is in correct mode
- Replace the remote control batteries
- Clean the upper edge of the remote control (transmission window)
- Check the battery terminals
- Turn off the product and unplug the AC cable from the wall socket and then plug the AC cable and turn on the product

### **“No signal” message is displayed**

- Check that the signal cable is firmly connected to the source input
- Check that the source is turned on

### **On PC mode, “Not Supported Mode” message is displayed**

- Check the maximum resolution and the frequency of the video adapter. For HD models the recommended resolution is 1366x768 and for Full HD models the recommended resolution is 1920x1080 (for PC mode). In HDMI mode the

recommended resolution is  
3840x2160@60Hz

### **The image is too light or too dark**

- Adjust the Brightness and Contrast

### **Pixel Mapping**

- It is recommended to choose aspect ratio PointToPoint or JUST SCAN to achieve pixel mapping in HDMI modes

## **Warranty and Service**

The following terms apply only to new "in the original carton" SWEDX products marketed and distributed by SWEDX, which are purchased and used by the original consumer purchaser.

Depending on the model, your terms and conditions may be different from those shown below, and this information is subject to change without prior notice. Unless specifically stated otherwise, used and reconditioned products that are resold have no warranty from SWEDX and are considered sold "AS-IS", however, the selling dealer may offer additional service options.

### **Warranty for SWEDX products:**

Check with your dealer for the warranty period.

#### **What the warranty covers:**

SWEDX warrants your SWEDX display(s) against defects in material and workmanship during the warranty period from SWEDX factory delivery date shown in the shipping documents. If a product proves to be defective in material or workmanship during the warranty period, SWEDX will, at its sole option repair or replace the product with a similar product, provided the purchaser adheres to certain return authorization procedures and guidelines. SWEDX reserves the right to charge customer in case of warranty conditions not are fulfilled.

#### **Who the warranty protects:**

This warranty is valid only for the first purchaser.

#### **What the warranty does not cover:**

1. Any product which the serial number has been defaced, modified or removed.
2. Damage, deterioration or malfunction resulting from:
  - A. Accident, misuse, neglect, fire, water, lightning, or other acts of nature, unauthorized product modification, or failure to follow instructions supplied with the product.
  - B. Repair or attempted repair by anyone not authorized by SWEDX.
  - C. Any damage of the product due to shipment.
  - D. Removal or installation of the product.
  - E. Causes external to the product, such as electric power fluctuations or failure.
  - F. Use of supplies or parts not meeting SWEDX specifications.
  - G. Normal wear and tear.
  - H. Any other cause which does not relate to a product defect.
3. Cosmetic damage by purchaser, such as markings, discoloration, scratches, dents, anti-theft devices markings, gouges or any

other defacement.

4. Physically damaged products by purchaser, such as broken PCB, Housing, damaged LCD Module.
5. No Defect Found (product returned to SWEDX as defective but failure is not duplicated by SWEDX's test method.)
6. The product is not in accordance with the fault in the application
7. Timber is a lifelike natural material which can cause some little changes in the precision of the produced product such as small openings line beside the connecting point and some other small changes which are out of SWEDX control and don't make any effect for the product functionality.

#### **Dead on Arrival (DOA)**

If the product fails within the manufacturer's DOA period, a replacement product will be offered.

#### **Before contacting us:**

In many cases, your product may not need repair. Before you contact us, please consult the troubleshooting section in your user's manual or SWEDX's FAQ web pages at <http://www.swedx.com> to see if you can easily remedy the problem yourself.

**How to get service:**

For information on obtaining warranty service, contact SWEDX dealer (the place where you bought your product) in first choice. If for any reason you can not contact your dealer, please contact SWEDX Customer Service by visiting <http://www.swedx.com>.

**SWEDX technical support services:**

During the period of product warranty, we support your basic configuration, setup and troubleshooting questions, and when required, we provide you with all instructions on how to return your product for repair. For support inquiries, please visit <http://www.swedx.com>.

SWEDX reserves the right to make final decisions regarding problem determination and the appropriate service option. Exchange units assume the remaining warranty of the original product. Please refer to your SWEDX Limited Warranty Statement for complete terms and conditions, as some models have other terms and conditions. Some limitations and restrictions apply and these programs are subject to change without prior notice.

**Limitation of liability**

If your SWEDX product fails to work as warranted above, your sole and exclusive remedy shall be repaired or replaced. SWEDX's maximum liability under this limited warranty is expressly limited to the lesser of the price you have paid for the product or the cost of repairing or replacement of any hardware components that malfunction in conditions of normal use. SWEDX is not liable for any damages caused by the product or the failure of the product to perform, including any lost profits or savings or special, incidental, or consequential damages. SWEDX is not liable for any claim made by a third party or made by you for a third party.

This limitation of liability applies whether damages are sought, or a claim made, under this limited warranty or as a tort claim (including negligence and strict product liability), a contract claim, or any other claim. This limitation of liability cannot be waived or amended by any person. This limitation of liability will be effective even if you have advised SWEDX.





# SWEDX

Your Digital Signage Partner



[www.swedx.com](http://www.swedx.com)

